

ESH

Diagrama de Capacidad ESH

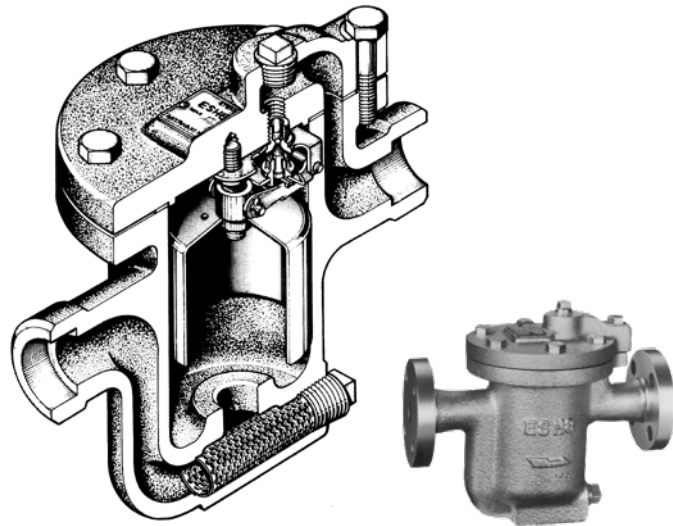
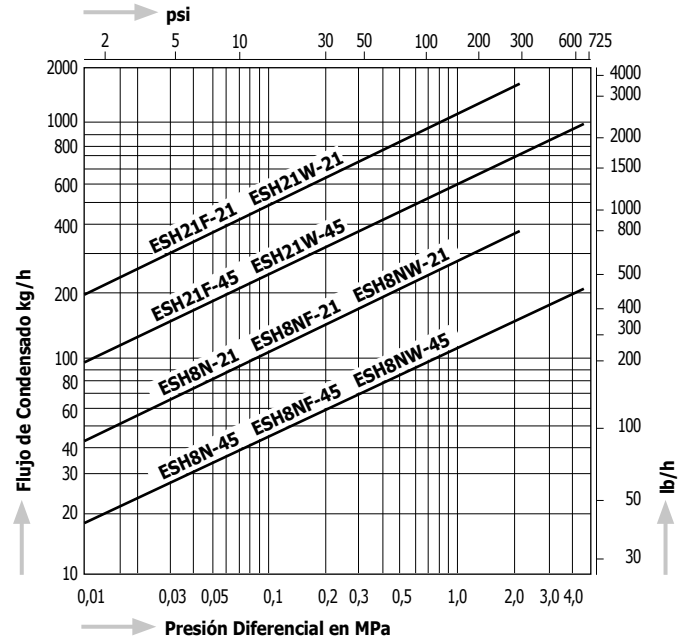

Dimensiones

ESH8N, ESH8NW

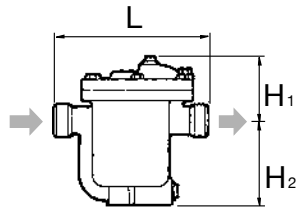

ESH8NF

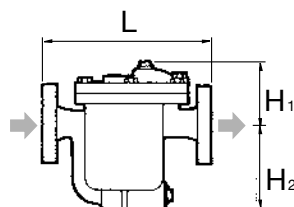

ESH21W

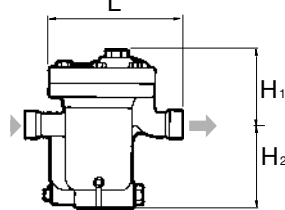

ESH21F

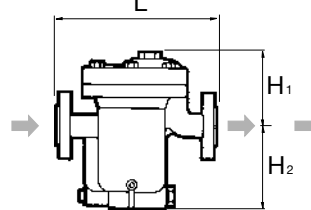

Todos los tipos

Roscada, Soldable (Socket Weld)

Bridada

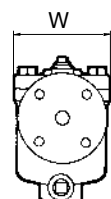
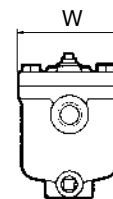

Tabla 1: Pesos

Tamaño	Peso (kg)									Peso (lb)										
	JIS (FF, RF)			JIS (RF)		ASME/JPI (RF)			DIN		JIS (FF, RF)			JIS (RF)		ASME/JPI (RF)			DIN	
	10K, 16K	20K	30K	40K	150lb	300lb	600lb	PN40	PN100	10K, 16K	20K	30K	40K	150lb	300lb	600lb	PN40	PN100		
½"	11,0	11,0	12,4	12,8	11,4	12,1	12,1	11,3	12,2	24,2	24,2	27,3	28,2	25,1	26,6	26,6	24,9	26,9		
¾"	12,4	12,4	13,7	14,0	11,8	12,8	13,2	12,9	15,0	27,3	27,3	30,2	30,8	26,0	28,2	29,1	28,4	33,0		
1"	13,2	13,6	14,6	15,0	12,4	13,6	14,0	15,0	18,3	29,1	29,9	32,1	33,0	27,3	29,9	30,8	33,0	40,3		

Modelo	Tipo de Conexión	Tamaño	Máx. presión de operación		Máx. temperatura de operación		Dimensiones (mm)				Dimensiones (in)				Material del Cuerpo	Peso	
			MPa	psig	°C	°F	L	H1	H2	W	L	H1	H2	W		kg	lb
			ESH8N - 21/45	Roscada Rc, NPT	½" - 1"	2,1 4,4	305 640	400	752	½" - ¾" = 220 1" = 224	114	111	146	½" - ¾" = 8.7 1" = 8.8		4.5	4.4
ESH8NF - 21/45	Bridada JIS, ASME, DIN	½" - 1"	2,1 4,4	305 640	250	114	111			146	9.8	4.5	4.4	5.7	Tabla 1	Tabla 1	
ESH8NW - 21/45	Soldable (Socket Weld) JIS, ASME, DIN	½" - 1"	2,1 4,4	305 640	220	114	111			146	8.7	4.5	4.4	5.7	11,0	24,2	
ESH21F - 21/45	Bridada JIS, ASME, DIN	½" - 1"	2,1 4,4	305 640	350	145	160			205	13.8	5.7	6.3	8.1	31,0	68,3	
ESH21W - 21/45	Soldable (Socket Weld) JIS, ASME, DIN	½" - 1"	2,1 4,4	305 640	300	145	160			205	11.8	5.7	6.3	8.1	28,0	61,7	

También disponible como diseño especial, con material del cuerpo en acero inoxidable. Para obtener más información, comuníquese con MIYAWAKI Inc. o con un representante autorizado.